

Fieldpiece

Refrigerant
Recovery Machine

OPERATOR'S MANUAL

Model MR45

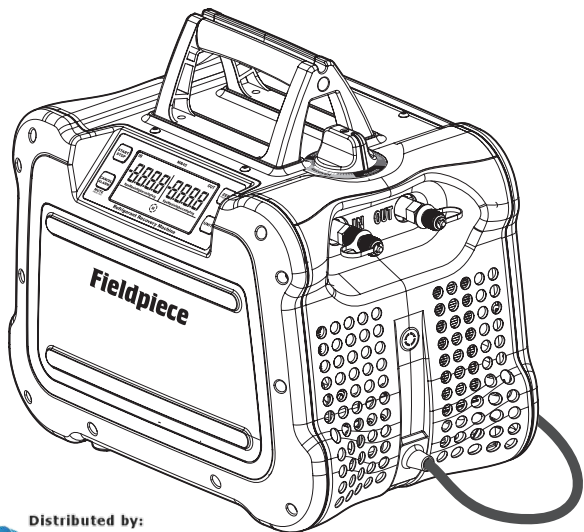

Distributed by:



TESTERSANDTOOLS.COM

Trust Experience Reliability

sales@testersandtools.com

Tel: 602-795-4033, Fax: 602-795-4624

Contents

Important Notice	4	Controls	14
What's Included.	4	Display and Buttons	
Warnings	4	Status Icons and Messages	
Certifications	5	Port Routing Control	
Description	6	MR45 Refrigerant Flow	
Features		Dynamic Pressure Measurement	
Specifications	8	Functions	22
Safety Information.	10	Self Test	
First Aid for Refrigerant Exposure		Self Purge	
General		Purging a Recovery Cylinder	
Environmental		Direct Liquid/Vapor Recovery	
Personal Protection		Push/Pull Recovery	
MR45 Protection		Troubleshooting	28
Setup		Status Messages	
Operational		Other Symptoms	
Tech Tips	12	Maintenance.	30
General		General	
Setup		Mesh Screen Filter	
Operational		Limited Warranty	32
		Obtaining Service	

Important Notice

This is not a consumer machine. Only qualified personnel trained in the recovery or pumping of refrigerant may operate this machine.

Read and understand this operator's manual in its entirety before using MR45 to prevent injury or damage to you or equipment.

What's Included

- MR45 Refrigerant Recovery Machine
- 10 Extra Mesh Screens for Input Port
- 3 Extra O-ring for Input Port
- Operator's Manual
- 1 Year Warranty

WARNINGS

Do not use to pump hydrocarbons, explosion risk.

Do not use to pump flammable media, explosion risk.

Inhalation of high concentrations of refrigerant vapor can block oxygen to the brain causing injury or death.

Refrigerant liquid can cause frostbite.

Certifications



WEEE

Do not dispose through typical waste streams.



IN ACCORDANCE WITH SECTION 608 OF THE CLEAN AIR ACT:

THIS EQUIPMENT HAS BEEN CERTIFIED BY UNDERWRITERS LABORATORIES INC. TO MEET EPA'S MINIMUM REQUIREMENTS FOR RECOVERY EQUIPMENT INTENDED FOR USE WITH REFRIGERANTS LISTED IN TABLE 4, AHRI 740-98

Description

The MR45 is the first variable speed DC motor recovery machine with a digital display. Pump refrigerant easier and quieter than ever before. Connect your hoses without navigating around dark tight spaces or picking the pump off the ground. View status messages and pressures directly on the big bright display.

Carry the machine to and from the job site easily and well protected from environmental hazards. Turn the single rubberized control valve to route refrigerant through MR45, and use the self-purge function to pump the last traces into the recovery cylinder instead of being left in the machine or released into the environment.

Features

- **Lightweight (22 lbs)**
- **Smooth and Fast Operation (1 HP DC Motor)**
- **Digital Display with Status Messages**
- **Reliable Rubberized Construction**
- **Easy to Access Port Design**
- **Hex Nut Secures Input Port During Hose Removal**
- **Power Cord Storage**
- **Ceramic Cylinders**
- **Self Purge**
- **Operation in the Rain (IP24)**
- **Wide Operating Voltage (95 to 130 VAC)**
- **UL Verified to Section 608 of EPA Clean Air Act**
- **UL Verified to AHRI Standard 740**

Specifications

Display: 2 x 10000 count LCD with status messages

Backlight: Blue color

Measurement rate: 3.3 times per second, nominal

Input Port Pressure Sensor Range: -30" Hg to 600 psig

Output Port Pressure Sensor Range: -30" Hg to 600 psig

High Pressure Cutoff: 558 psig, nominal

Resolution and Units: 1 psig (1" Hg), 0.05 bar (2 cmHg),
0.01 Mpa (2 cmHg), 5 Kpa (2 cmHg)

Pressure Sensor Accuracy:

± 0.5" Hg (Vacuum)

± (0.6% of reading +2 psig)

Final Recovery Vacuum: 14.9" Hg

Compressor: Twin cylinder reciprocating (oil-less)

DC Motor: 1 HP (variable smart speed)

Power Source: 95 to 130 VAC @ 60 Hz 1 phase

Max Current Draw: 12.0 AAC

Valve: Single dual-route ball valve

Input Port Filtration: 9 mm mesh screen, stainless

Dimensions: 14.8" x 9.8" x 13.5"
376 mm x 250 mm x 344 mm

Weight: 22 lbs

Operating Environment: 32°F to 122°F (0°C to 50°C)

Storage Environment: -4°F to 140°F (-20°C to 60°C)

Approved Refrigerants: R12, R134A, R22, R401A (MP39),
R401B, R401C, R402A, R402B, R404A, R406A, R407A, R407B,
R407C, R407D, R408A, R409A, R410A, R411A, R411B, R412A,
R500, R502, R507, R509.

Safety Information

First Aid for Refrigerant Exposure

Inhaled: Move to fresh air immediately.

Eye: Immediately flush eye with water. Seek medical attention.

Skin: Immediately flush skin with water. Seek medical attention.

General

1. This is not a consumer machine. Only qualified personnel trained in the recovery or pumping of refrigerant may operate this machine.
2. Read and understand this operator's manual in its entirety before using MR45 to prevent injury or damage to you or equipment.

Environmental

1. Use only within operating conditions (32-122°F)
2. Ensure fan opening is clear of debris.
3. Explosion and fire risks:
 - Do not use near sewer lines.
 - Do not use in poorly ventilated enclosed areas.
 - Do not use near gasoline, acetylene, or other flammable gases.
 - Do not use to pump hydrocarbons.
 - Do not use near flames or sparks.
 - Assume all components are pressurized.

Personal Protection

1. Frostbite danger. Be careful using hoses.
2. Use personal protective equipment:
 - Wear safety goggles.
 - Wear earplugs if using for long durations.
 - Wear protective gloves.

MR45 Protection

1. Use only on approved list of refrigerants (page 9).
2. Do not use with hydrocarbons.
3. Ensure mesh screen filter is installed and clean (page 30).

Setup

1. Repair any damaged parts before using.
2. Disconnect power and allow fan to stop before opening or servicing MR45.
3. Perform self test periodically (page 22).
4. Ensure power cord is not damaged.
5. Ensure all equipment is grounded.
6. Extension cord options:
 - 14 AWG or thicker, up to 50 feet (15 m)
 - 12 AWG or thicker, up to 100 feet (30 m)
7. Ensure extension cord is grounded, 3 conductor grounded.

Operational

1. Use correct refrigerant hoses with ball valve shutoffs.
2. Keep track of the current amount of refrigerant in the cylinder. Refrigerant scales are a good way to do this.
3. Overfilling a cylinder past 80% can cause an explosion and violates DOT laws.
4. Close cylinder off from refrigerant if it reaches 80% of its capacity.
5. Use only DOT CFR 49 or UL-approved refrigerant cylinders for the refrigerant being recovered.
6. Use recommended accessories.
7. Use a small filter drier on the input port and change it often to protect machine from contaminated refrigerants.
8. Monitor pressures and temperatures.
9. Self purge MR45 after each use. No refrigerant should remain in the machine.

Tech Tips

General

1. Store in the self purge or recover position. Do not store in the CLOSED position as trapped air and refrigerant can expand and damage components.
2. For extended storage, purge with nitrogen, set to RECOVER, and screw non-sealing caps onto the ports.
3. Recovery machines are not vacuum pumps and should not be used for deep evacuations.
4. Do not run the machine without the mesh screen filter (page 30). Doing so will void the warranty and damage the machine.
5. Understand the refrigerant safety data sheet (SDS).

Setup

1. Know the refrigerant of the system and make sure your recovery cylinder matches that type.
2. Hoses:
Short as possible (3/8" hose with 1/4" fitting).
Core depressors removed.
Ball valve shutoffs instead of low loss fittings.
Replace if worn.
3. Manifold gauges are not necessary for recovery but can make it more convenient and increase speed by having 2 system hook ups.
4. Use a Schrader valve core removal tool to temporarily remove valve cores from service valves.
5. Use the push-pull method if recovering over 30 lbs.
6. Evacuate your empty recovery cylinders to 29.6" Hg before use.

7. Know how much refrigerant you expect to recover before starting.
8. Ensure there's enough room in the recovery cylinder to not exceed 80% filled during the job, or monitor and have a second cylinder ready.
9. Always purge hoses before recovery. If cylinder is too hot, use an ice bath to reduce the temperature and pressure of the cylinder.
10. If cylinder pressure is higher than expected, you can purge non-condensables into another cylinder (page 23).

Operational

1. Recover as much liquid as possible before recovering vapor.
2. Recovery is faster when the recovery cylinder is cooler.
3. You can use a heat gun to warm refrigerant lines to boil trapped refrigerant.
4. Recover from both suction and liquid lines at the same time for faster vapor recovery.

Controls

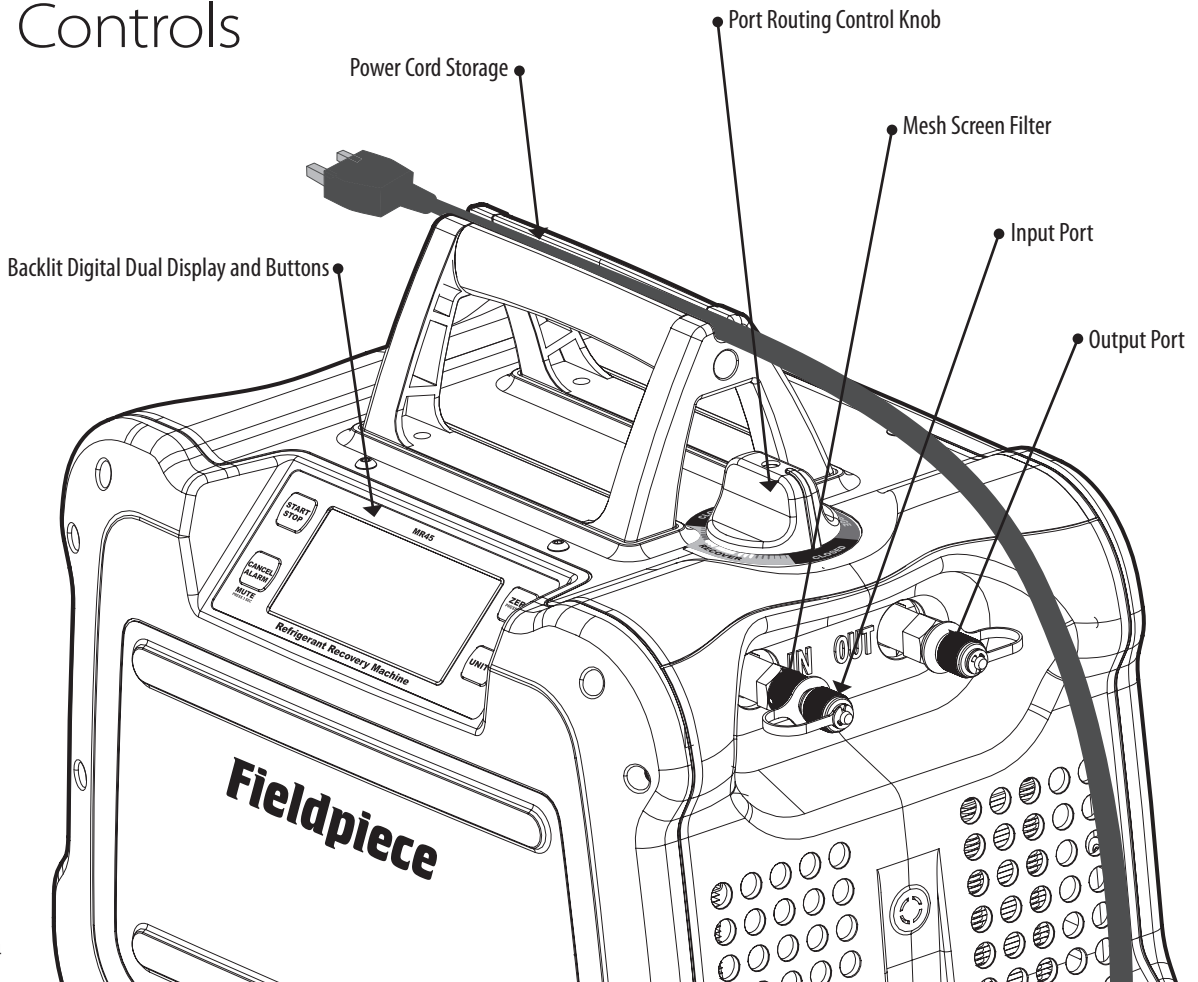

Display and Buttons

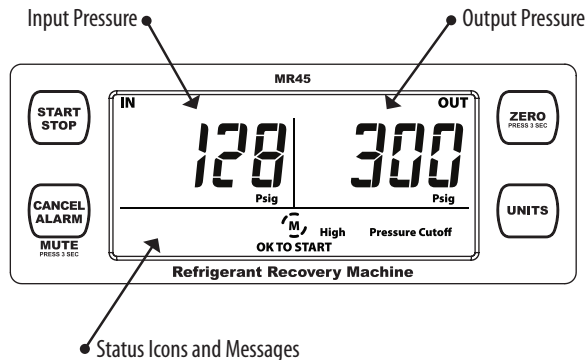

START/STOP

Start or Stop the motor.

ZERO (press 3 seconds)

Zero pressure sensors. Ports must be open to atmosphere.

CANCEL ALARM

Cancel alarm currently sounding (temporarily mute).

MUTE (press 3 seconds)

Toggle mute for all sounds (setting is saved).

UNITS

Select pressure/vacuum units.

Status Icons and Messages

 The icon rotates when the motor is running.

 The icon is shown when MR45 is set to MUTE.

OK TO START

Motor stopped. Temperatures, voltages, and pressures are currently safe to start the motor again.

COMPLETE

Motor stopped. Purge or recovery has reached 10" Hg or 20" Hg vacuum for 10 sec.

Input Closed

Cannot zero pressures. Open input port.

Output Closed

Cannot zero pressures. Open output port.

High Voltage Warning

Motor stopped. Voltage was above 130 VAC.

Low Voltage Warning

Motor stopped. Voltage was below 95 VAC.

High Pressure Cutoff

Motor stopped. Output (cylinder) approached dangerous pressure.

Low Pressure Cutoff

Motor stopped. Input reached 10" Hg or 20" Hg vacuum for 10 sec.

Motor Fault 1

Motor stopped. Motor temp. measured above operating range.

Motor Fault 2 ("throttle" shows on display)

Motor stopped. Motor current (amps) rose above operating range. Throttle RECOVERY to reduce cylinder pressure (page 19).

Motor Fault 3

Motor stopped for unknown reason.

Port Routing Control

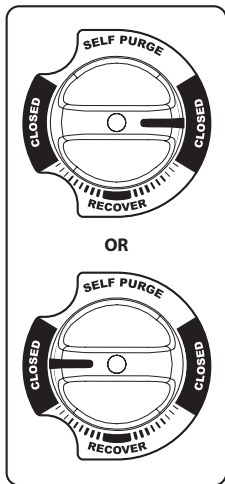

OR

CLOSED

- Input and Output closed.
- Set to either closed position to close off both ports during setup.



SELF PURGE

- Input closed, Output open.
- After recovery is complete, set to this position to close the IN port before you START the purge.



RECOVER

- Input and Output fully open.
- Set to this fully open position for most of the recovery process.

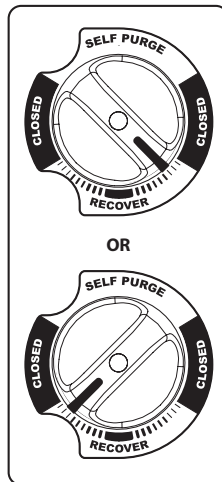

OR

RECOVER (throttled)

- Input and Output partially open.
- Rotate away from RECOVER in either direction to reduce liquid slugging if knocking occurs. This slows the flow of refrigerant so the machine operates more smoothly.
- Only throttle as much as needed for smooth operation.

MR45 Refrigerant Flow

Refrigerant liquid and vapor are pulled through the machine by the pressure difference created by the compressor. For maximum performance, increase the IN pressure and reduce the OUT pressure. See Tech Tips (page 12).

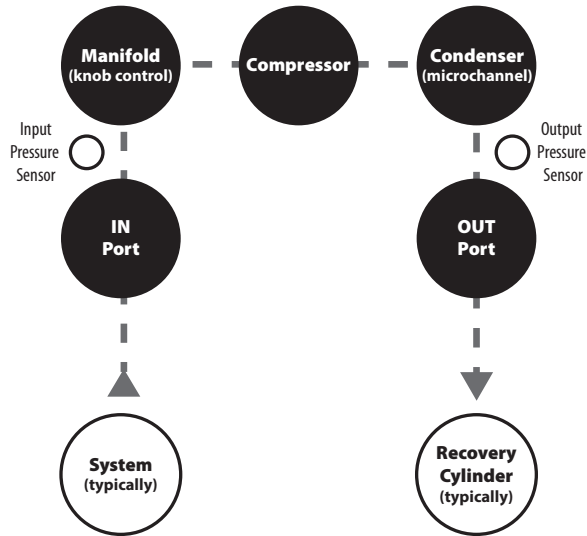

Dynamic Pressure Measurement

MR45 pressure readings are designed only for monitoring pressures. Do not use MR45 for diagnostic pressure measurements.

If a system's pressure is stable, MR45 pressure readings will be close to your other pressure gauges.

If a system's pressure is changing, pressure measurements at different locations within that system will be different. For every 3 feet of 1/4" hose, the pressure may have a difference of approximately ± 20 psig.

Functions

Self Test

Perform this test to ensure the high pressure cutoff and pump are operational.

1. Set knob to RECOVERY.
2. Open IN port to air.
3. Connect a ball valve to OUT port. (Included caps are not sealed.)
4. Close the ball valve.
5. Press START to create a pressure at the OUT port.
6. MR45 is working well if High Pressure Cutoff occurs around 550 psig within 45 seconds. Cutoff time can increase if a hose is placed in front of your ball valve.

Self Purge

Use the SELF PURGE feature at the end of every recovery to pump the last bit of refrigerant out of MR45. Benefits include increased machine life, reduced environmental impact, and most importantly to prevent refrigerant mixing.

1. After recovery is complete, set knob to SELF PURGE. This closes the IN port and routes the MR45 condenser to the intake of the MR45 compressor.
2. Press START to empty MR45 into the recovery cylinder.
3. Once 10" Hg is reached for 10 seconds, the motor stops automatically.

Purging a Recovery Cylinder

When the cylinder pressure is higher than expected you may have non-condensables at the top of the cylinder. Use a second deeply evacuated cylinder to pull out the non-condensables.

1. Leave pressurized cylinder undisturbed overnight.
2. Use a vacuum pump to evacuate another cylinder.
3. Use your manifold gauges to connect the closed vapor ports of the two cylinders.
4. Measure the vapor temperature of the pressurized refrigerant cylinder.
5. Use a P/T chart or digital manifold to find specified pressure.
6. Open the evacuated vapor port.
7. Open (purge) the pressurized vapor port until pressure is reduced to 5 psi above specified pressure.
8. Close valves.
9. If desired, repeat in 15 minutes to allow the tank to settle again.

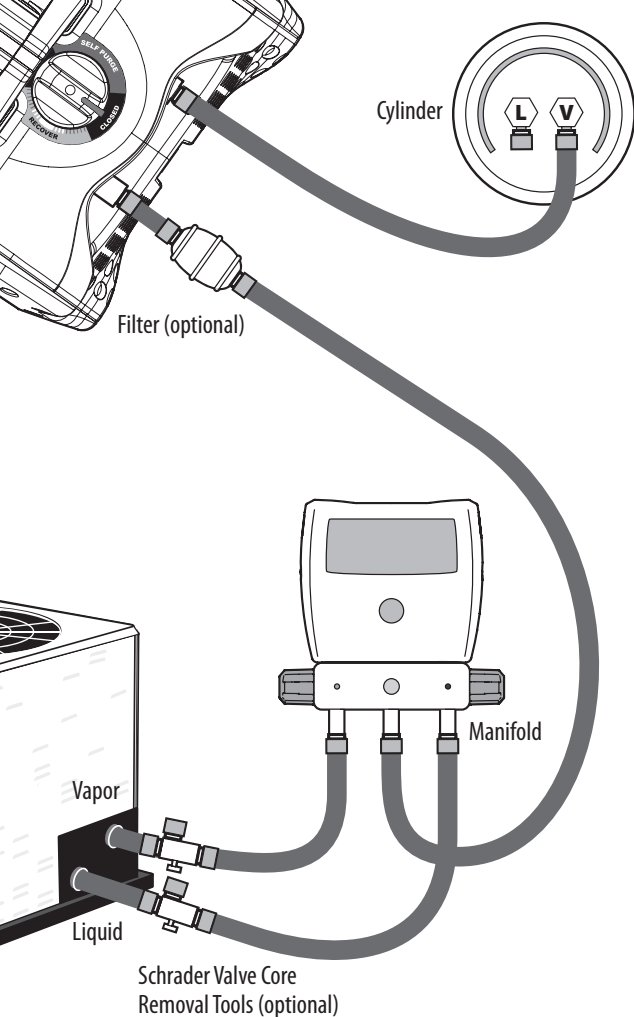

Direct Liquid/Vapor Recovery

This is the typical recovery method. Vapor and liquid lines are routed through your manifold, into MR45, and out to the recovery cylinder.

1. Close valves of recovery cylinder, MR45, and manifold.
2. Set up as shown in the diagram.
3. Open valves of hoses and removal tools.
4. Set MR45 to RECOVER.
5. Open high side of manifold for liquid recovery.
6. To purge air from hoses, briefly unseat hose fitting at cylinder until vapor is seen. Unseat hose fitting at low side of manifold to purge low side hose.
7. Fully open vapor valve of recovery cylinder.
8. Press START to begin recovery.
9. Adjust the knob as needed to throttle refrigerant flow if liquid slugging (knocking) occurs.
10. When liquid recovery is complete, open low side of manifold for vapor recovery.
11. MR45 stops automatically after vacuum reaches 10" Hg for 10 seconds. For a deeper vacuum, press START to continue recovery. MR45 stops again after vacuum reaches 20" Hg for 10 seconds. Press STOP to manually halt recovery at any time.
12. Set knob to SELF PURGE and press START to empty MR45. MR45 stops automatically after vacuum reaches 10" Hg for 10 seconds.
13. Close manifold and cylinder valves after self purge is complete.
14. Remove hoses from MR45, set knob to RECOVER, and cap ports.

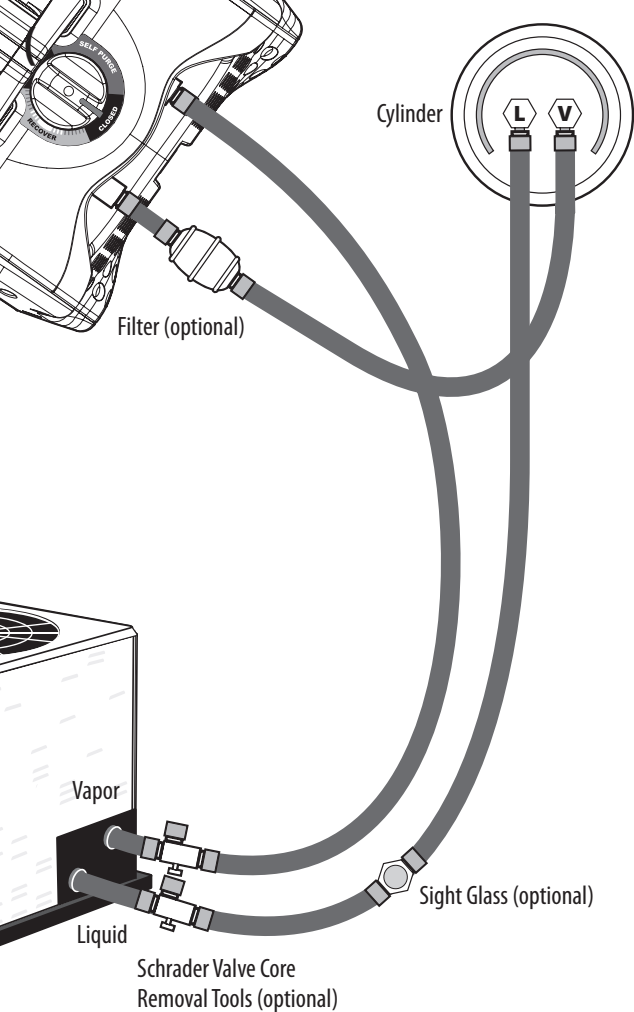

Push/Pull Recovery

This method is only for larger systems with at least 30 lbs of liquid refrigerant. It's used to recover liquid before recovering vapor.

1. Close valves of recovery cylinder and MR45.
2. Set up as shown in the diagram.
3. Open valves of liquid hose and removal tool at liquid system port.
4. To purge air from system liquid hose, briefly unseat hose fitting at cylinder's liquid port until vapor is seen.
5. Fully open liquid valve of recovery cylinder and allow to pressurize.
6. Set MR45 to RECOVER.
7. Press START to begin recovery.
8. Fully open vapor valve of recovery cylinder.
9. To purge air from hoses briefly unseat hose fitting at vapor system port until vapor is seen.
10. Open valves of vapor hose and removal tool at vapor system port.
11. When liquid recovery is complete, press STOP to stop motor.
12. Close all valves and proceed to Direct Vapor Recovery (page 25).

Troubleshooting

Status Messages

Input Closed

Cannot zero the displayed pressure because pressure sensor not open to atmosphere. Open input port.

Output Closed

Cannot zero the displayed pressure because pressure sensor not open to atmosphere. Open output port.

High Voltage Warning

Voltage was above 130 VAC. Motor stopped. Ensure power network voltage is between 95 and 130 VAC @ 60 Hz.

Low Voltage Warning

Voltage was below 95 VAC. Motor stopped. Check power network to ensure voltage is between 95 and 130 VAC @ 60 Hz.

High Pressure Cutoff

Output (cylinder) reached dangerous pressure. Motor stopped. Ensure all valves after the output port are open. The cylinder may need to be cooled or replaced to reduce pressure.

Low Pressure Cutoff

Input reached final recovery vacuum. Motor stopped. It's normal to see this after RECOVERY or SELF PURGE is complete. If unexpected, ensure valves before the input port are open and the knob is not set to CLOSED.

Motor Fault 1

Motor temperature measured above operating range. Motor stopped. Extremely high ambient temperature, extended liquid recovery time, or high cylinder pressure can be the cause. Allow time for the motor to cool down before resuming, and throttle the RECOVERY (page 19).

Motor Fault 2

Motor current (amps) rose above operating range. Motor stopped. Extremely high ambient temperature, harsh liquid slugging, extended recovery time, or high cylinder pressure can be the cause. Throttle RECOVERY and start the motor. If fault occurs again, throttle even more and start the motor (page 19).

Motor Fault 3

Motor stopped for unknown reason. If this occurs repeatedly, there may be something wrong with MR45.

Other Symptoms

MR45 never reaches 10”Hg or 20”Hg vacuum during recovery or self purge.

Check for a leakage before the input port.

For 10”Hg vacuum, the recovery cylinder should be below 475psig.

For 20”Hg vacuum, the recovery cylinder should be below 230psig.

Input port shows frost or signs of leakage.

Ensure the grooved input fitting is hand tight before tightening the hex nut (page 30).

Recovery is slower than normal.

There could be an input blockage. Check mesh screen filter for blockage. Ensure knob is set to RECOVER.

Display does not turn on when plugged in.

Ensure power cord and outlet are okay.

Excessive noise during liquid recovery.

MR45 is experiencing a high load. Rotate the knob of MR45 to throttle the refrigerant flow.

Maintenance

General

Wipe with damp cloth to clean the exterior.
Do not use solvents.

To extend the life of internal seals, occasionally pump a teaspoon of mineral oil through MR45.

Mesh Screen Filter

When the mesh screen filter becomes dirty and clogged, it means it's working to keep your MR45 working well for a long time. You need to clean or replace this screen often. Visit our website for information on obtaining extra mesh screens.

1. Loosen (counter clockwise) the securing hex nut on the IN port.
2. Unscrew (counter clockwise) the grooved input fitting.
3. Clean or replace the mesh screen.
4. Hand tighten (clockwise) the grooved input fitting.
5. Tighten (clockwise) the securing hex nut with 1/8 turn with a wrench.

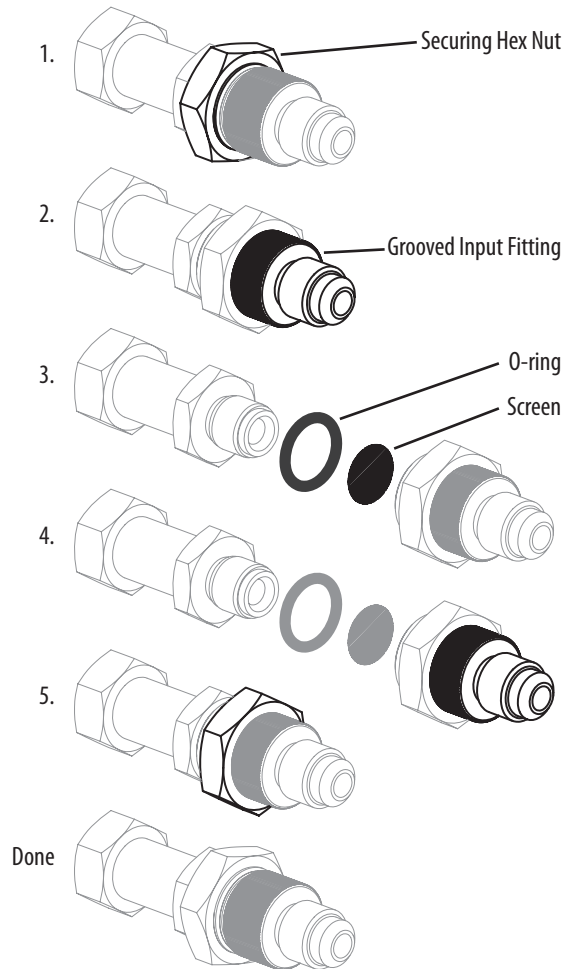

Limited Warranty

This machine is warranted against defects in material or workmanship for one year from date of purchase from an authorized Fieldpiece dealer. Fieldpiece will replace or repair the defective unit, at its option, subject to verification of the defect.

This warranty does not apply to defects resulting from abuse, neglect, accident, unauthorized repair, alteration, or unreasonable use of the machine.

Any implied warranties arising from the sale of a Fieldpiece product, including but not limited to implied warranties of merchantability and fitness for a particular purpose, are limited to the above. Fieldpiece shall not be liable for loss of use of the machine or other incidental or consequential damages, expenses, or economic loss, or for any claim of such damage, expenses, or economic loss.

State laws vary. The above limitations or exclusions may not apply to you.

Obtaining Service

Visit www.fieldpiece.com/rma for the latest information on how to obtain service.

MR45

© Fieldpiece Instruments, Inc 2017; v19

Distributed by:



TESTERSANDTOOLS.COM

Trust Experience Reliability

sales@testersandtools.com

Tel: 602-795-4033, Fax: 602-795-4624